



$n \approx 2900 \text{ об/мин}$



Вертикальный многоступенчатый насос из нержавеющей стали 304



Технические характеристики

50 Гц $n \approx 2900 \text{ об/мин}$

Описание товара

- Вертикальный многоступенчатый центробежный насос из нержавеющей стали 304.
- Всасывающие и нагнетательные патрубки расположены на одной оси. Легкая установка в линию (in-line).
- Головная часть насоса и основание насосов CDM изготовлены из чугуна.
- Рабочее колесо и вал насоса CDM изготовлены из нержавеющей стали.
- Все проточные детали насоса CDMF изготовлены из нержавеющей стали.
- Насосы оснащены высокоэффективным двигателем IE3 с классом защиты IP55 F.
- Качественный подшипник, износостойкое механическое уплотнение.
- Круглый фланец.
- Температура жидкости от -10°C до +120°C.

Эксплуатация

Многоступенчатые насосы из нержавеющей стали подходят для промышленных технологических систем, систем промывки, перекачки кислот и щелочей, систем фильтрации, повышения давления воды, очистки воды, ирригации, систем противопожарной защиты и т.п.

Доступные опции по запросу

- ♦ Электродвигатель: Однофазный 230В-50Гц с тепловой защитой, встроенной в обмотку, до P2 = 2.2кВт
- ♦ Датчик РТС

Структура обозначения насоса

Пример

CDM (F) 15 - 9

9=Количество ступеней

15=Номинальный расход (м3/ч)

CDM=Вертикальный многоступенчатый насос общего типа

CDMF=Проточная часть насоса полностью выполнена из SS304

Модель	DN	Мощность		Q=Подача																			
		кВт	лс	л/мин	Н=Напор(м)																		
					0	8.3	11.7	16.7	20	23.3	26.7	30	33.3	36.7	40	46.7	50	53.3	60	66.7	73.3		
мм	кВт	лс	0	0.5	0.7	1	1.2	1.4	1.6	1.8	2	2.2	2.4	2.8	3	3.2	3.6	4	4.4				
CDM 1-2	25x25	0.37	0.5	11.8	11.5	11.2	10.5	10.3	9.7	9	8	6.8	5.5	4	-	-	-	-	-	-			
CDM 1-3	25x25	0.37	0.5	17.5	17	16.8	16	15.6	14.8	13.5	12	10	8.5	6	-	-	-	-	-	-			
CDM 1-4	25x25	0.37	0.5	23.5	23	22.5	21.5	21	19.8	18	16	13.5	11	8	-	-	-	-	-	-			
CDM 1-5	25x25	0.37	0.5	29	28.5	28	27	26	24.5	22.5	20	17	14	10	-	-	-	-	-	-			
CDM 1-6	25x25	0.37	0.5	35	34.5	34	32.5	31.5	30	27	24	20.5	17	12.5	-	-	-	-	-	-			
CDM 1-7	25x25	0.37	0.5	41	40.5	40	39	37	35	32	28	24	20	15	-	-	-	-	-	-			
CDM 1-8	25x25	0.55	0.75	47	46	45.5	43.5	42	40	37	33	29	24.5	18	-	-	-	-	-	-			
CDM 1-9	25x25	0.55	0.75	52.5	52	51.5	49	47	44.5	41	37	32	27	20.5	-	-	-	-	-	-			
CDM 1-10	25x25	0.55	0.75	58.5	58	57	55	52.5	50	46	42	37	31	23	-	-	-	-	-	-			
CDM 1-11	25x25	0.55	0.75	64	63.5	63	61	58.5	55	51	46	40	33.5	25.5	-	-	-	-	-	-			
CDM 1-12	25x25	0.75	1	70	69	68.5	67	64.5	61	57	52	45.5	37	28	-	-	-	-	-	-			
CDM 1-13	25x25	0.75	1	75.5	75	74.5	73	70	66.5	61.5	56	49	40.5	31	-	-	-	-	-	-			
CDM 1-15	25x25	0.75	1	87.5	86.5	85.5	84	81	76.5	71	65	57	47	36	-	-	-	-	-	-			
CDM 1-17	25x25	1.1	1.5	99	98	97	95	91.5	86.5	81	73	64	53	41	-	-	-	-	-	-			
CDM 1-19	25x25	1.1	1.5	110	109	108	106	103	98	91	82	72	59	46	-	-	-	-	-	-			
CDM 1-21	25x25	1.1	1.5	122	121	120	117	113	107	100	90	78	65	50	-	-	-	-	-	-			
CDM 1-22	25x25	1.1	1.5	128	127	126	122	118	112	105	95	83	69	54	-	-	-	-	-	-			
CDM 1-23	25x25	1.5	2	134	133	132	128	123	118	111	102	90.5	76.5	58	-	-	-	-	-	-			
CDM 1-25	25x25	1.5	2	146	145	144	139	134	128	121	111	98	83	63	-	-	-	-	-	-			
CDM 1-27	25x25	1.5	2	158	157	155	150	145	138	130	119	106	90	69	-	-	-	-	-	-			
CDM 1-30	25x25	1.5	2	175	174	172	167	161	154	145	133	118	100	77	-	-	-	-	-	-			
CDM 1-32	25x25	2.2	3	189	188	186	180	174	166	155	143	129	110	85	-	-	-	-	-	-			
CDM 1-33	25x25	2.2	3	195	194	192	186	180	171	160	148	133	113	87	-	-	-	-	-	-			
CDM 1-34	25x25	2.2	3	200	199	198	192	185	176	165	152	137	117	90	-	-	-	-	-	-			
CDM 1-36	25x25	2.2	3	212	211	209	203	196	186	175	161	145	124	95	-	-	-	-	-	-			
CDM 1-38	25x25	2.2	3	225	224	221	215	208	197	185	171	153	131	101	-	-	-	-	-	-			
CDM 1-40	25x25	2.2	3	237	236	233	226	219	208	195	180	161	138	106	-	-	-	-	-	-			
CDM 3-2	25x25	0.37	0.5	14.7	-	-	-	14	14	13.5	13	13	12.5	11.5	11	10.5	9.5	8	6	-			
CDM 3-3	25x25	0.37	0.5	22.2	-	-	-	21.5	21	21	21	20.5	20	19.5	18	17	16.5	15	12.5	9.5			
CDM 3-4	25x25	0.37	0.5	29.7	-	-	-	29	29	28.5	28	27.5	27	26	24	23	22	20	17	13			
CDM 3-5	25x25	0.55	0.75	37.2	-	-	-	36	36	35	34	33.5	33	32	30	29	28	25	21	16			
CDM 3-6	25x25	0.55	0.75	45	-	-	-	43.5	43	42.5	42	41	40	39	36.5	35	33.5	30	25	19.5			
CDM 3-7	25x25	0.75	1	52.5	-	-	-	51	51	50	50	49	48	46	43	41	39.5	35	30	23			
CDM 3-8	25x25	0.75	1	60	-	-	-	58.5	58	58	57	56	55	53	49	47	45	40	34	26.5			
CDM 3-9	25x25	1.1	1.5	67.5	-	-	-	66	66	65	64	63	62	60	56	53	51	45	38	30			
CDM 3-10	25x25	1.1	1.5	75	-	-	-	73	73	72	71	70	68	66	61	59	56	50	42	33.5			
CDM 3-11	25x25	1.1	1.5	82.5	-	-	-	80	80	79	78	77	75	73	68	65	62	55	47	37			
CDM 3-12	25x25	1.1	1.5	90	-	-	-	88	87	86	85	83	81	79	74	71	67	59	50	40.5			
CDM 3-13	25x25	1.5	2	98	-	-	-	95	94	93	92	90	88	86	80	77	73	64	54	44			
CDM 3-14	25x25	1.5	2	105	-	-	-	102	102	101	100	98	95	92.5	86	83	78	69	58	47			
CDM 3-15	25x25	1.5	2	113	-	-	-	110	109	108	107	105	103	100	94	90	86	76	64	51			
CDM 3-16	25x25	1.5	2	120	-	-	-	118	117	116	114	112	110	107	100	96	92	81	69	54			
CDM 3-18	25x25	2.2	3	136	-	-	-	133	132	130	128	126	123	120	113	108	102	90	76	61			
CDM 3-19	25x25	2.2	3	143	-	-	-	140	139	137	135	132	129	126	119	114	108	96	82	64			
CDM 3-20	25x25	2.2	3	151	-	-	-	148	146	144	142	140	137	133	125	120	114	100	85	67			
CDM 3-21	25x25	2.2	3	158	-	-	-	155	154	152	150	147	144	140	131	126	120	106	90	71			
CDM 3-22	25x25	2.2	3	166	-	-	-	162	160	158	156	154	150	146	137	132	125	110	93	74			
CDM 3-23	25x25	2.2	3	173	-	-	-	170	168	166	164	161	157	153	144	138	131	115	97	78			
CDM 3-24	25x25	2.2	3	181	-	-	-	177	175	173	171	168	164	160	150	144	137	120	101	81			
CDM 3-25	25x25	3	4	188	-	-	-	185	183	181	178	175	171	166	156	150	142	125	105	85			
CDM 3-27	25x25	3	4	204	-	-	-	200	198	195	192	188	184	180	169	162	155	138	117	92			
CDM 3-28	25x25	3	4	212	-	-	-	207	205	202	199	195	191	187	175	168	160	143	121	95			
CDM 3-29	25x25	3	4	220	-	-	-	215	213	210	207	203	199	194	182	175	167	148	126	99			
CDM 3-31	25x25	3	4	235	-	-	-	230	227	224	220	216	212	207	194	187	178	159	134	106			

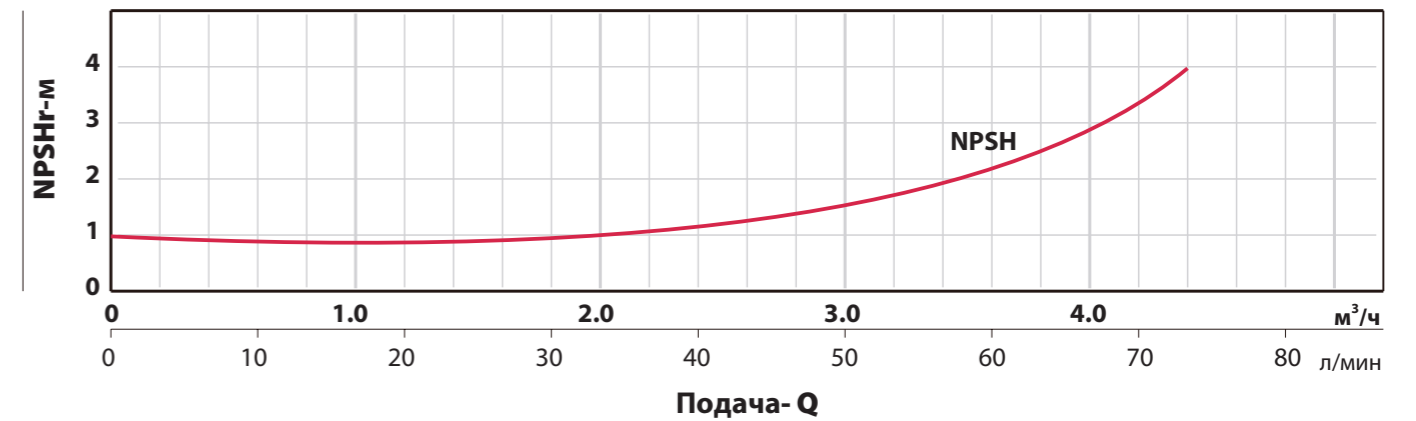
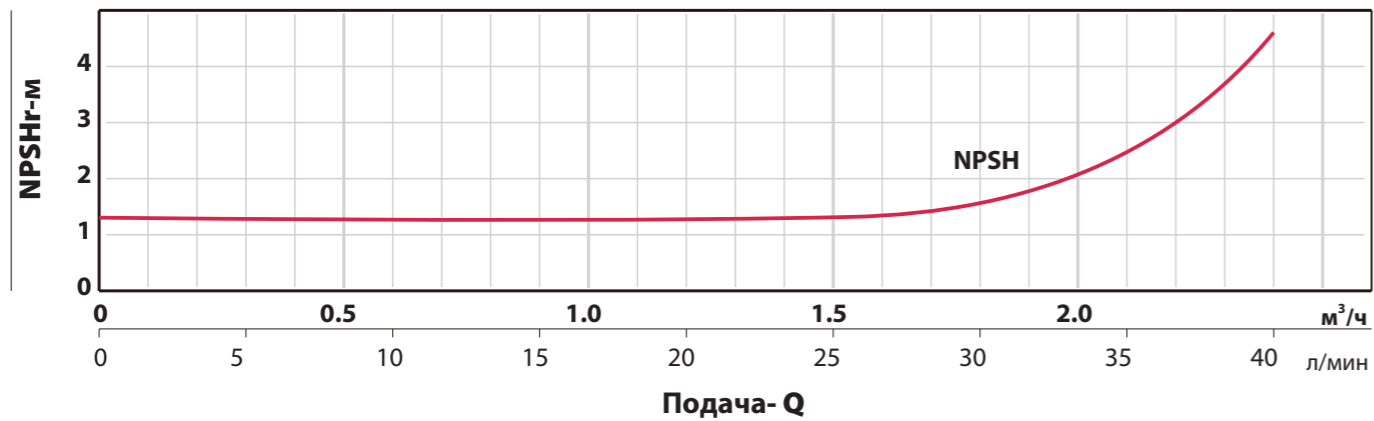
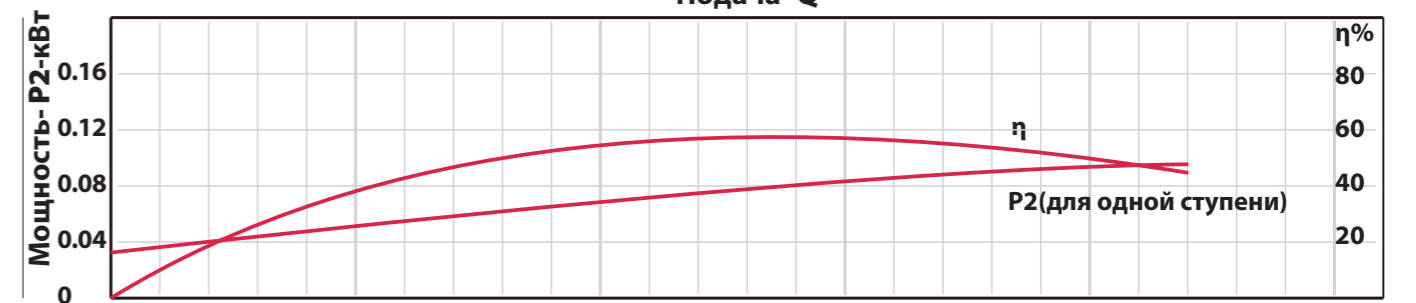
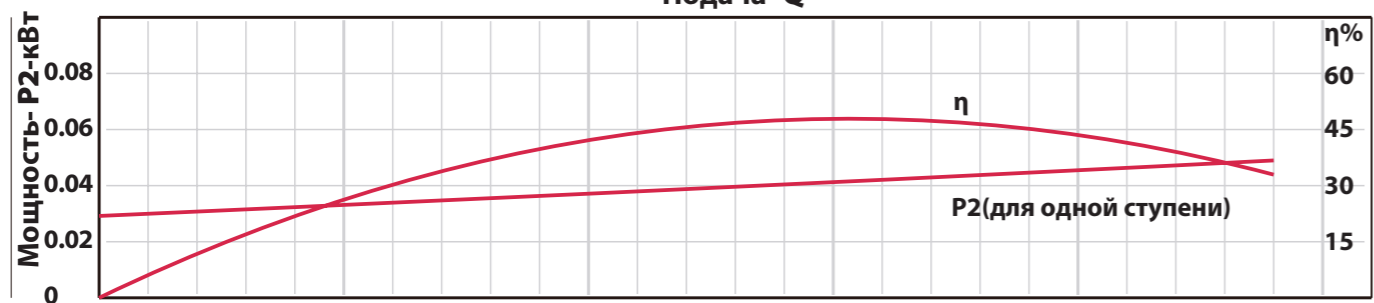
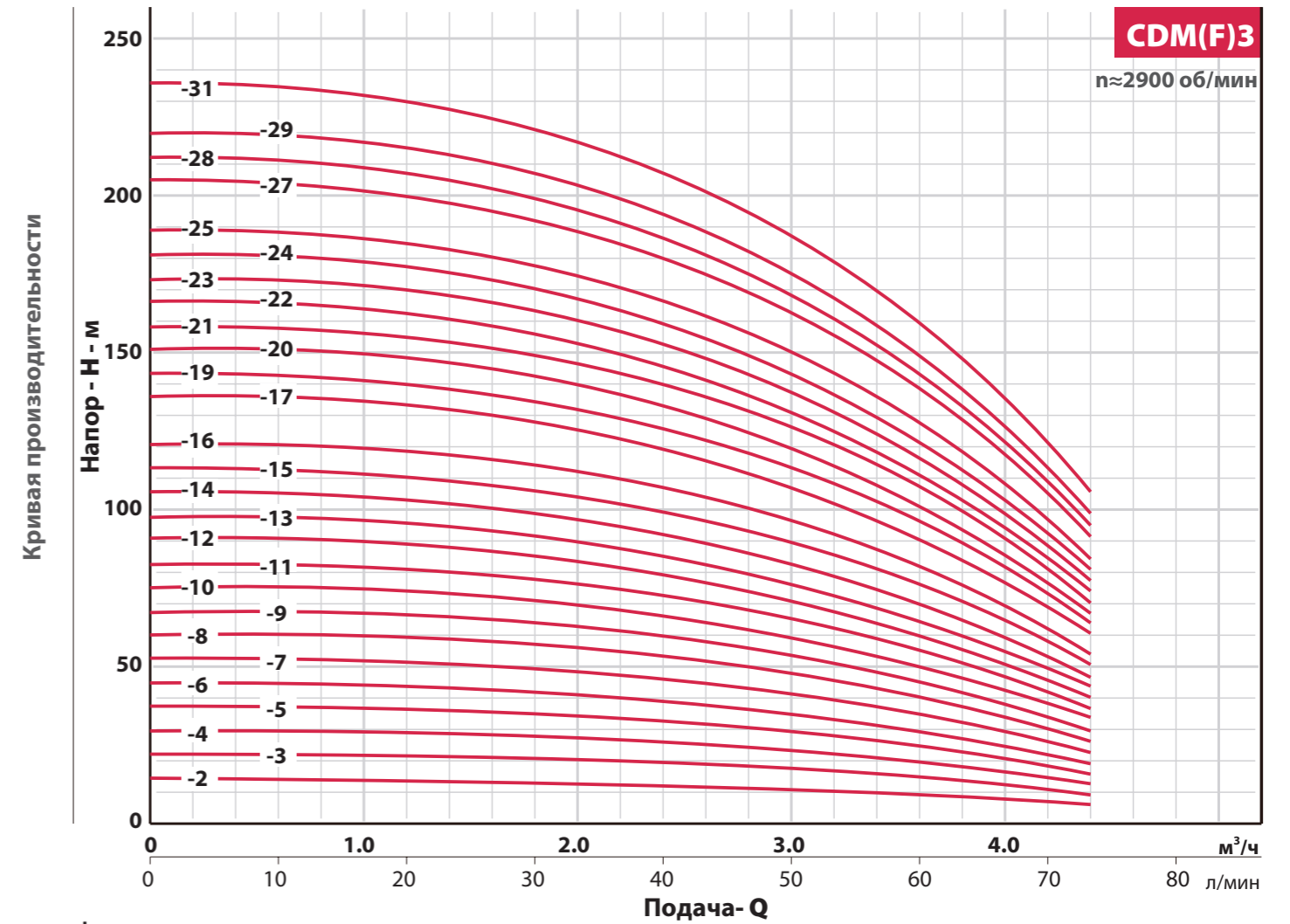
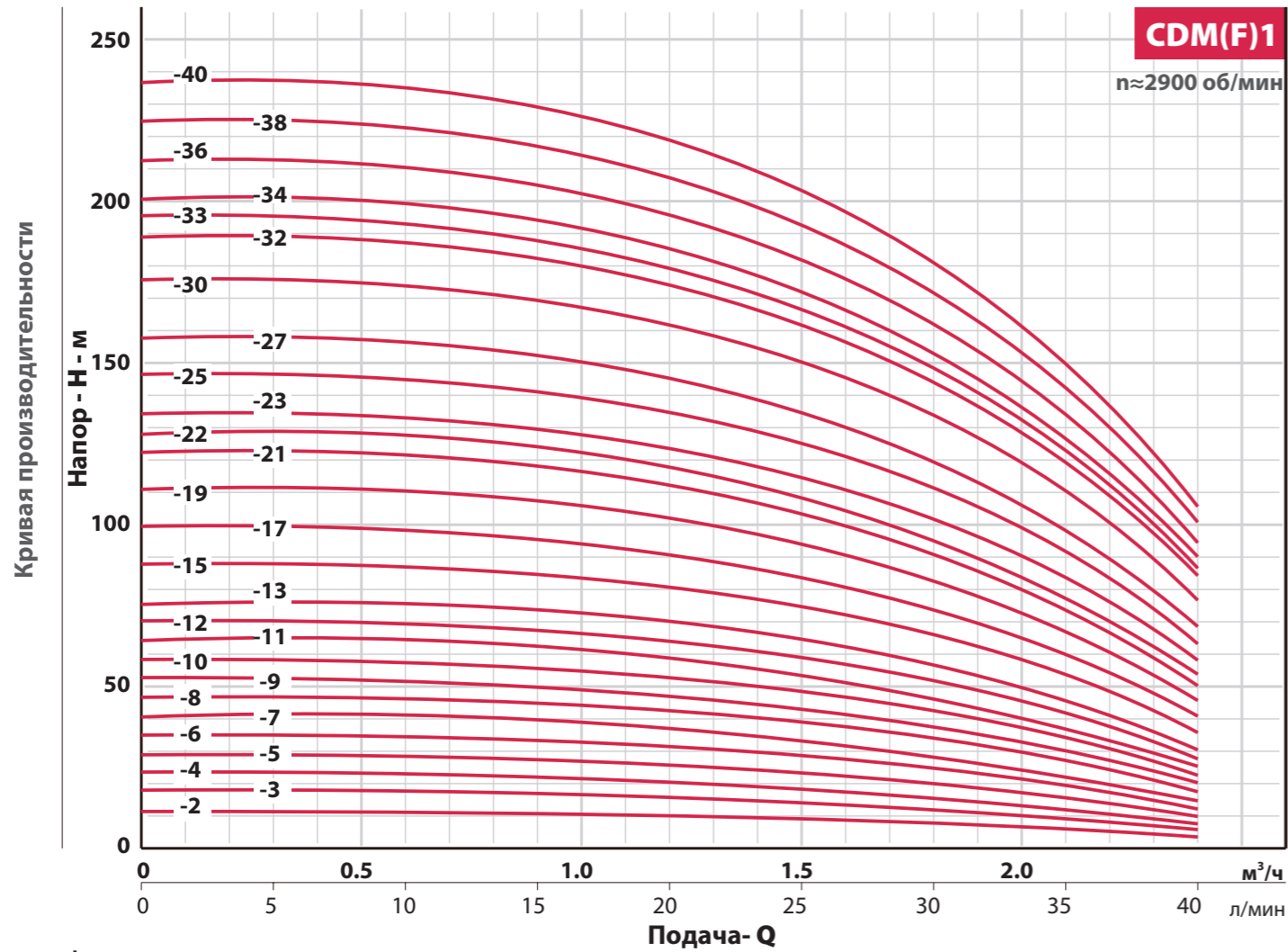

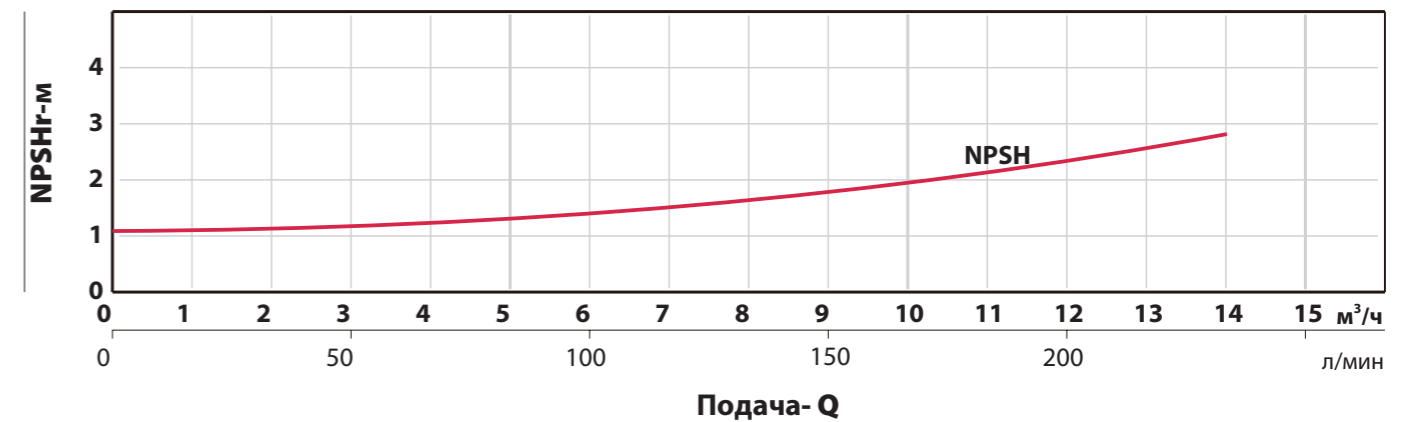
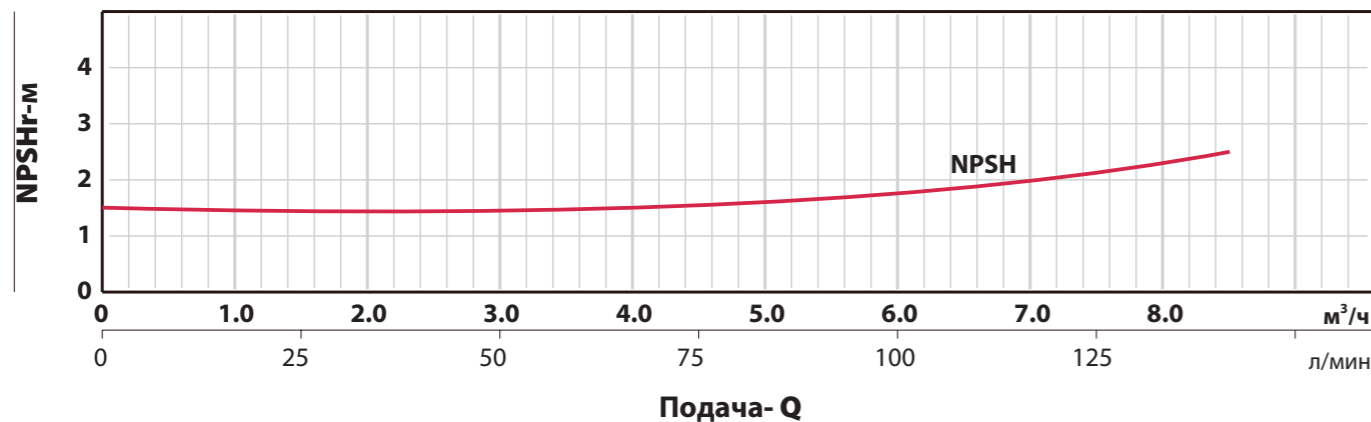
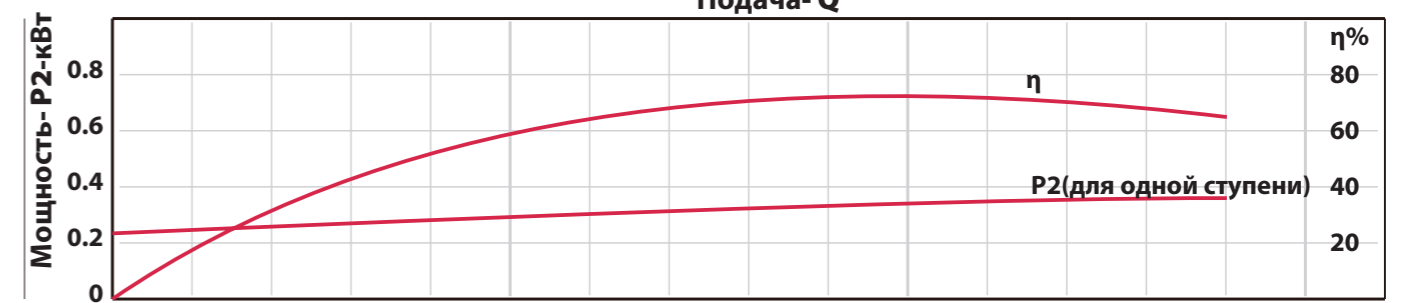
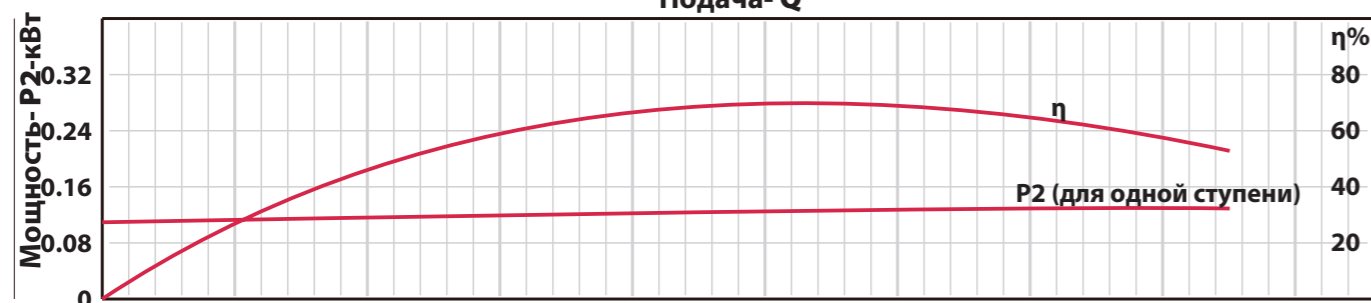
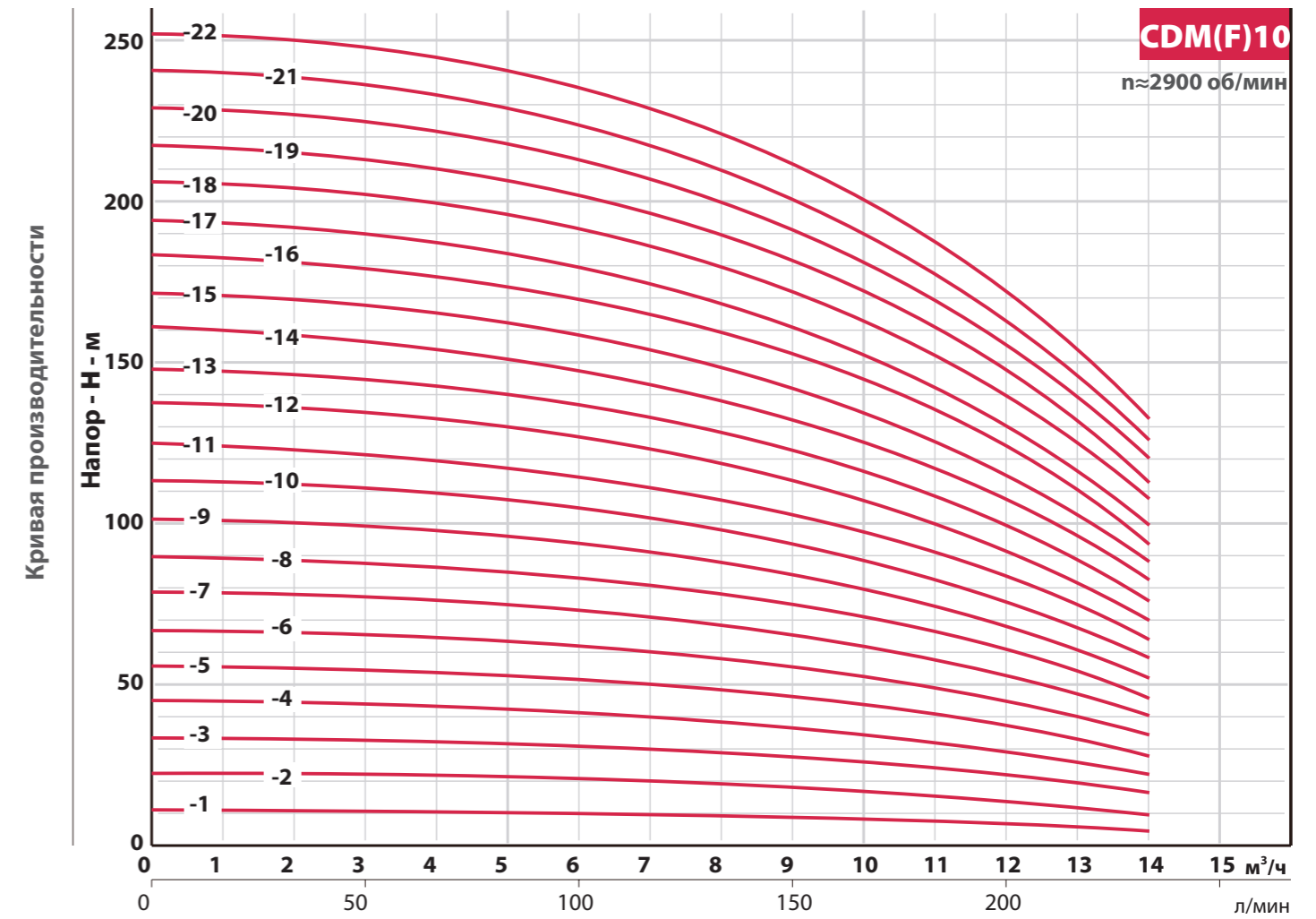
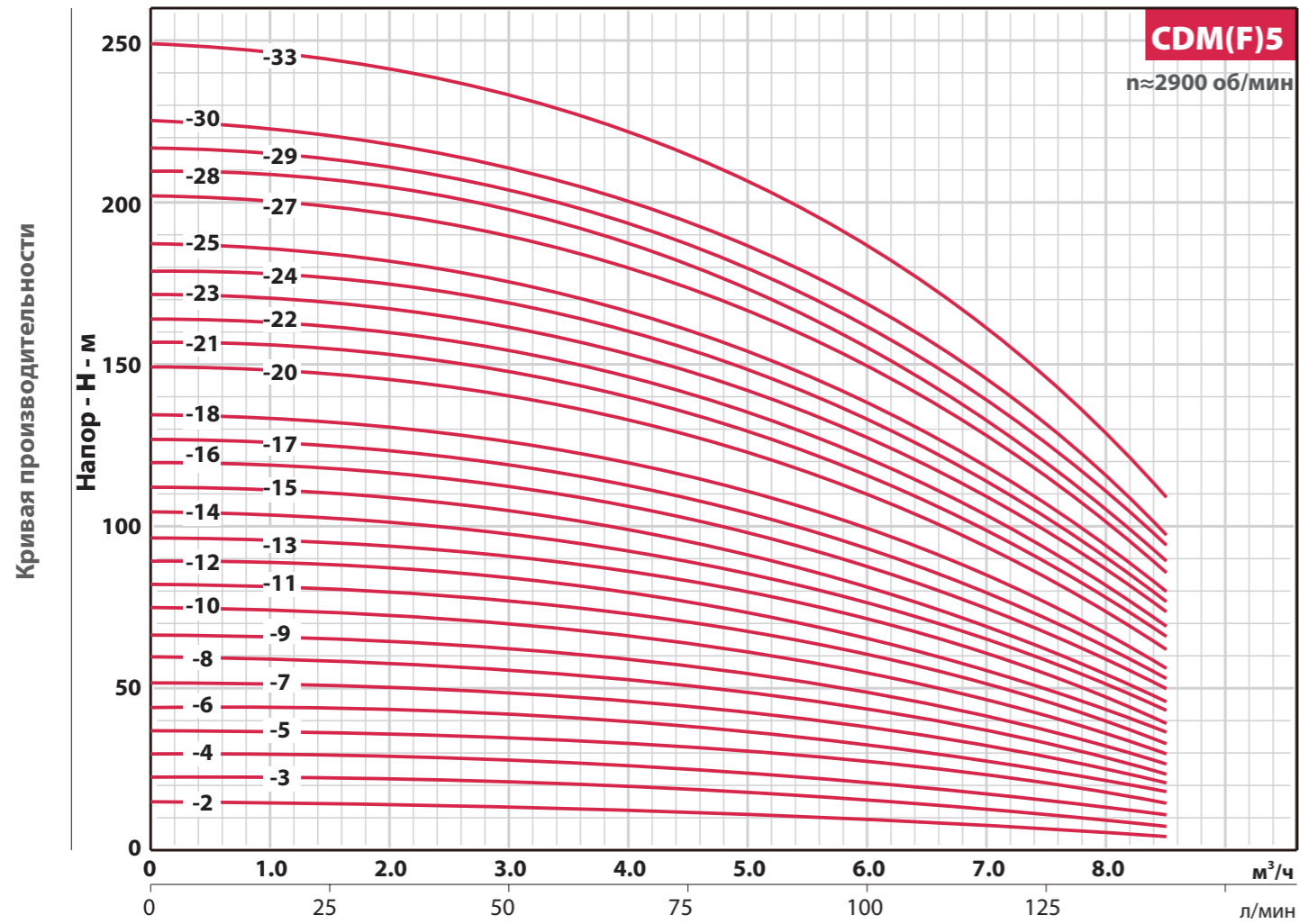

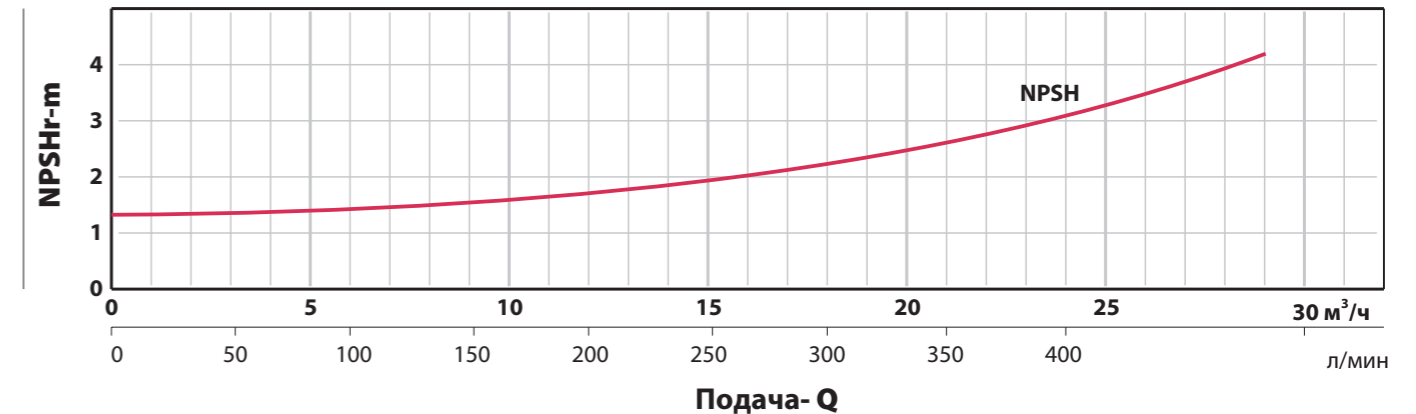
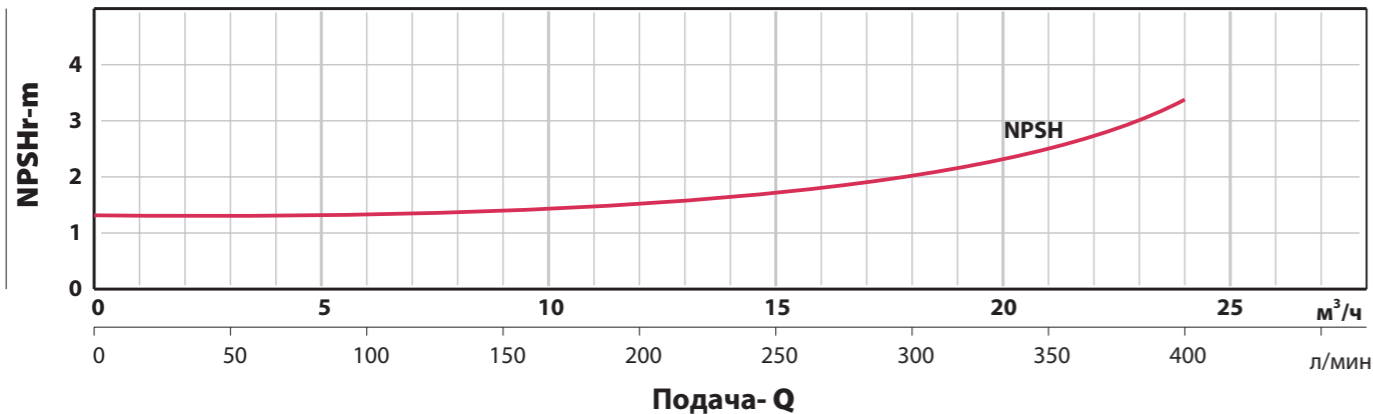
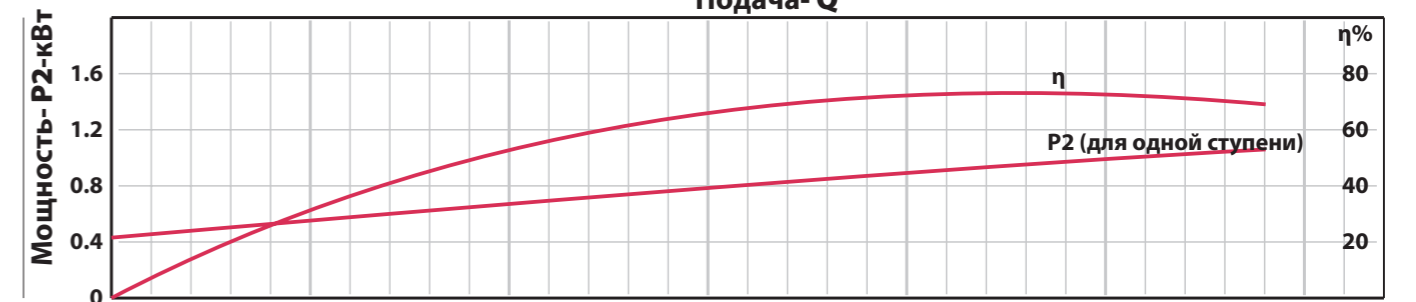
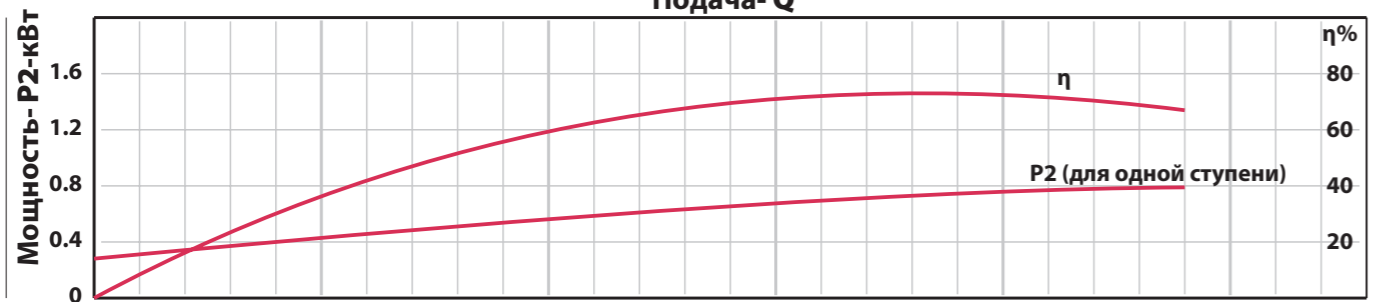
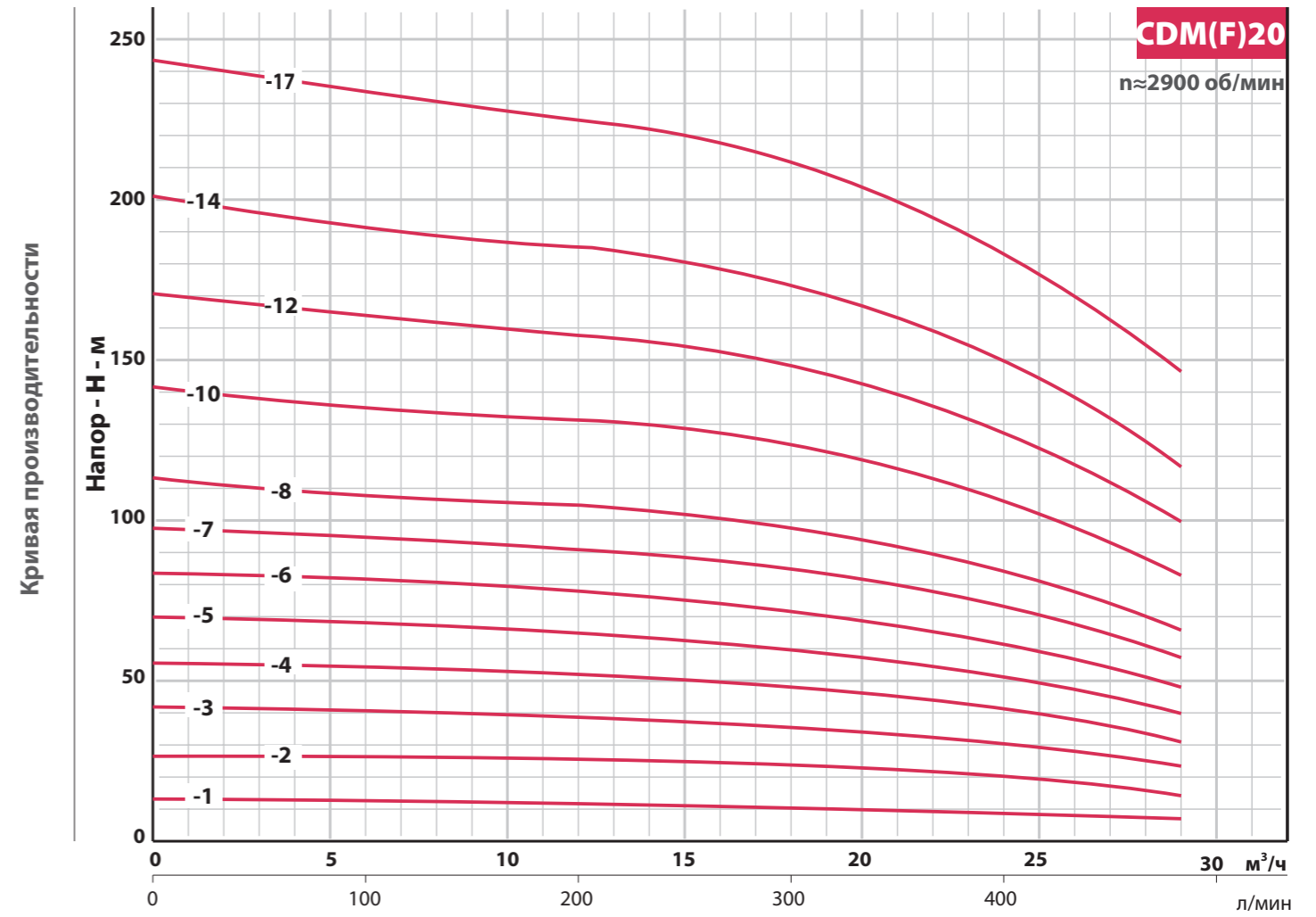
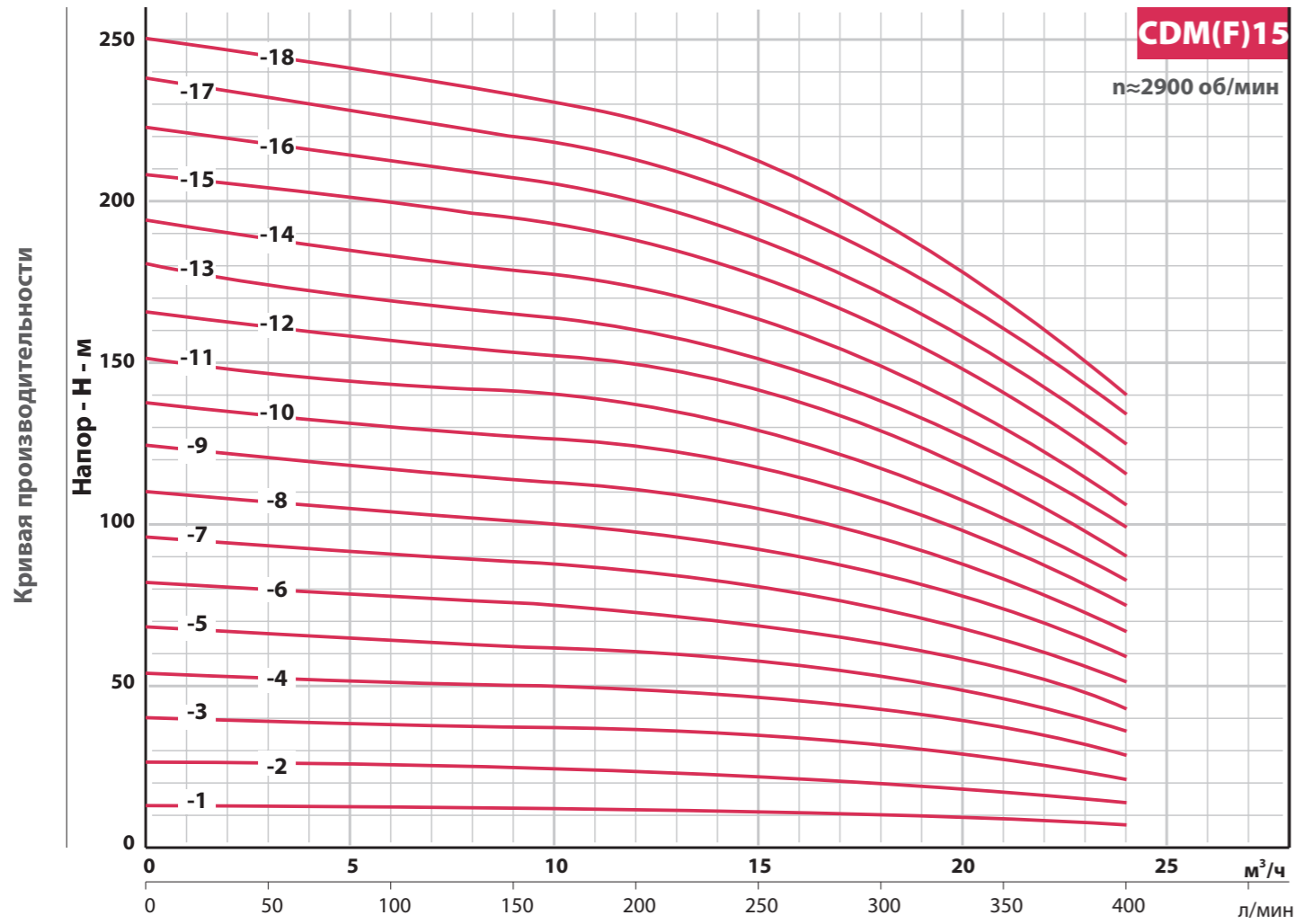

CDM(F)32

2900 об/мин

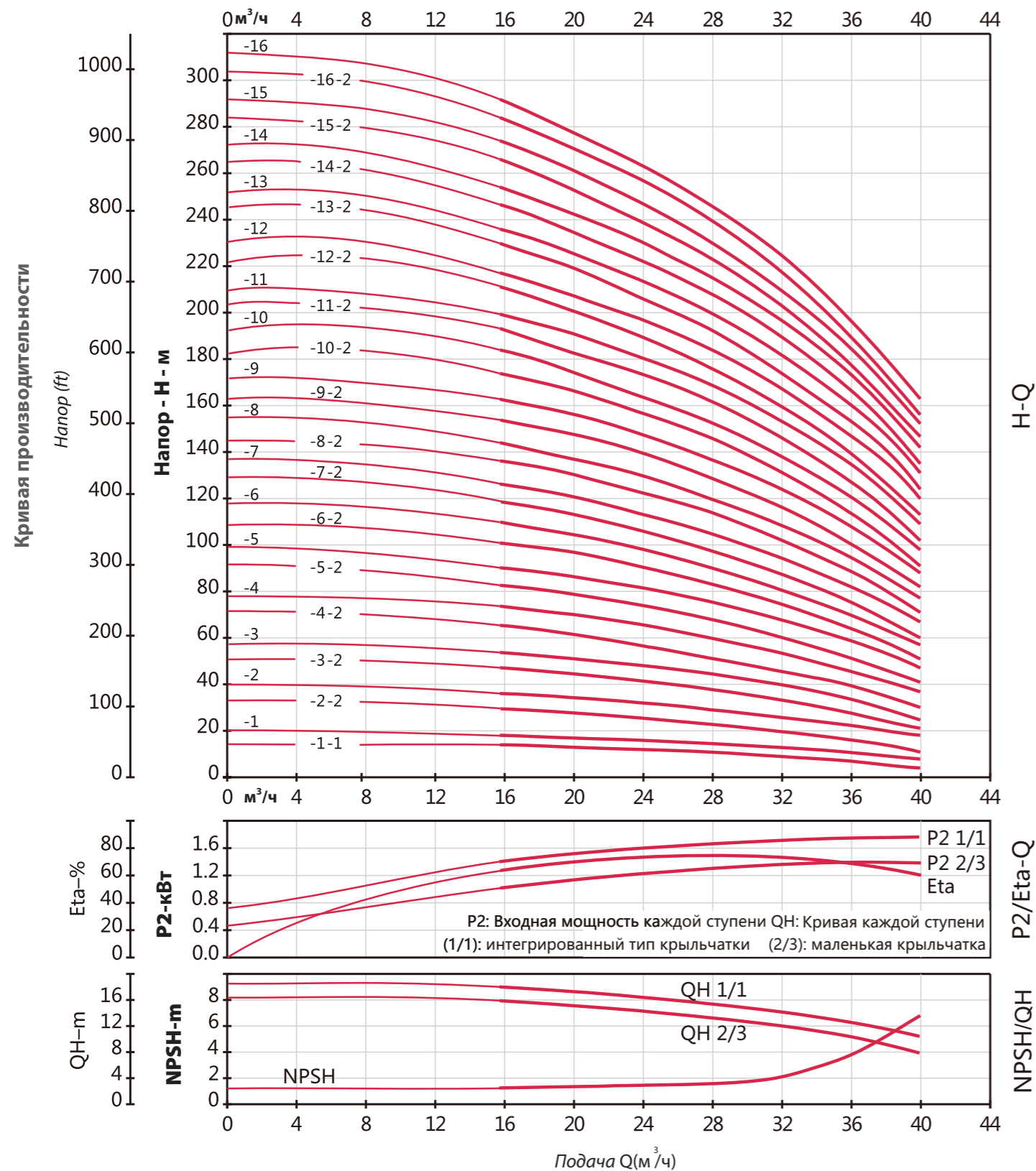

CDM(F)42

2900 об/мин

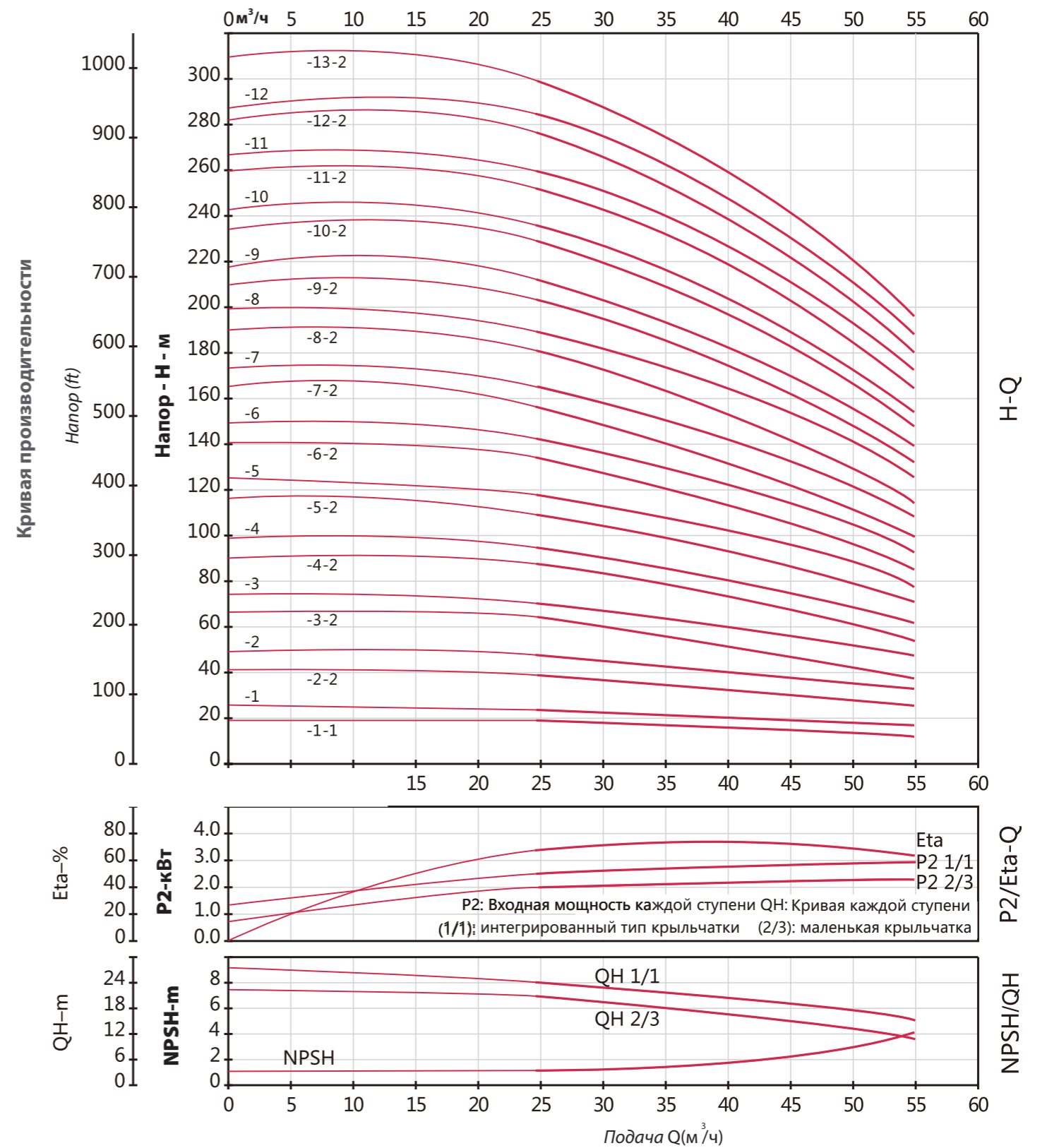

CDM(F)65

2900 об/мин

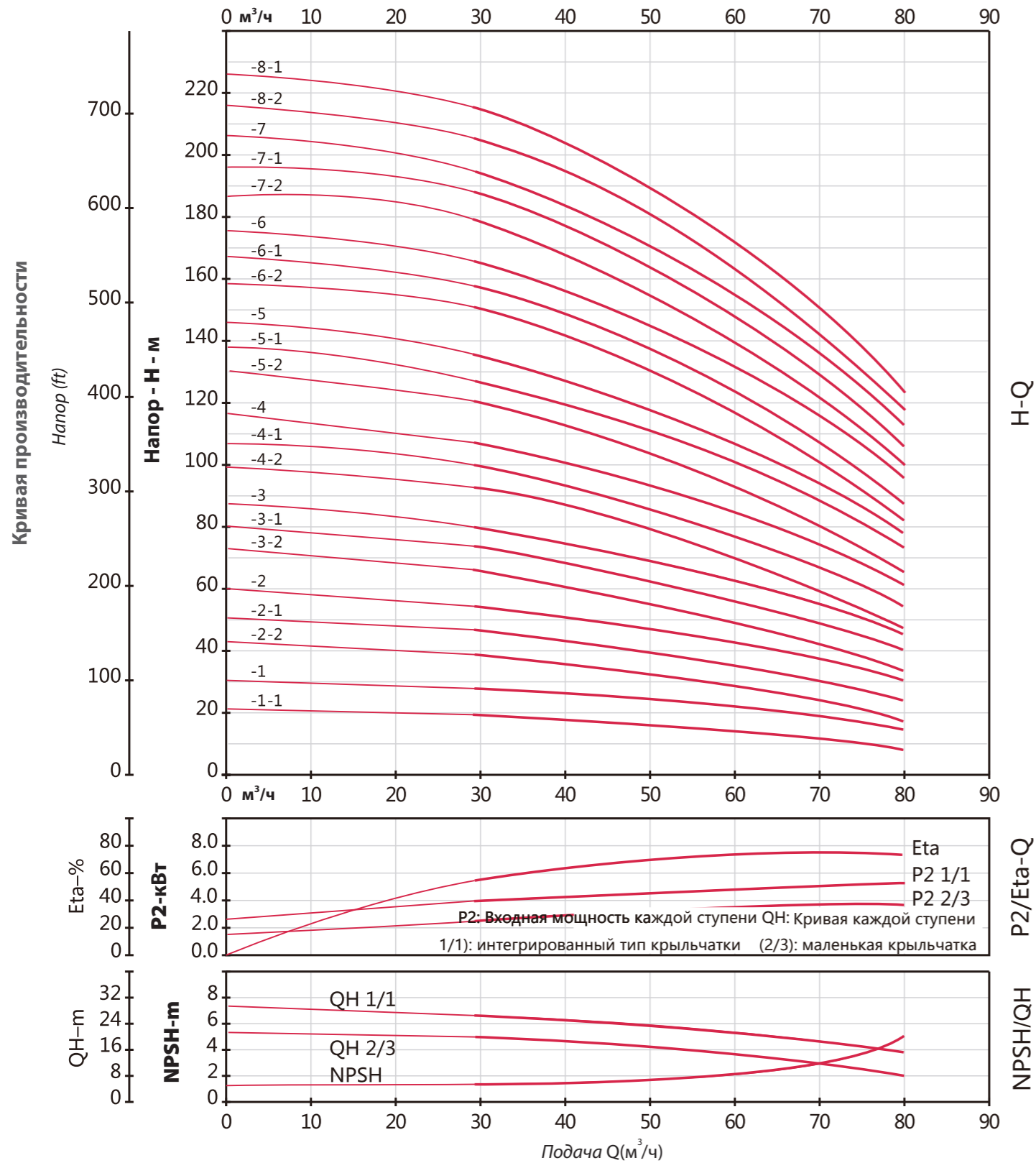

CDM(F)85

2900 об/мин

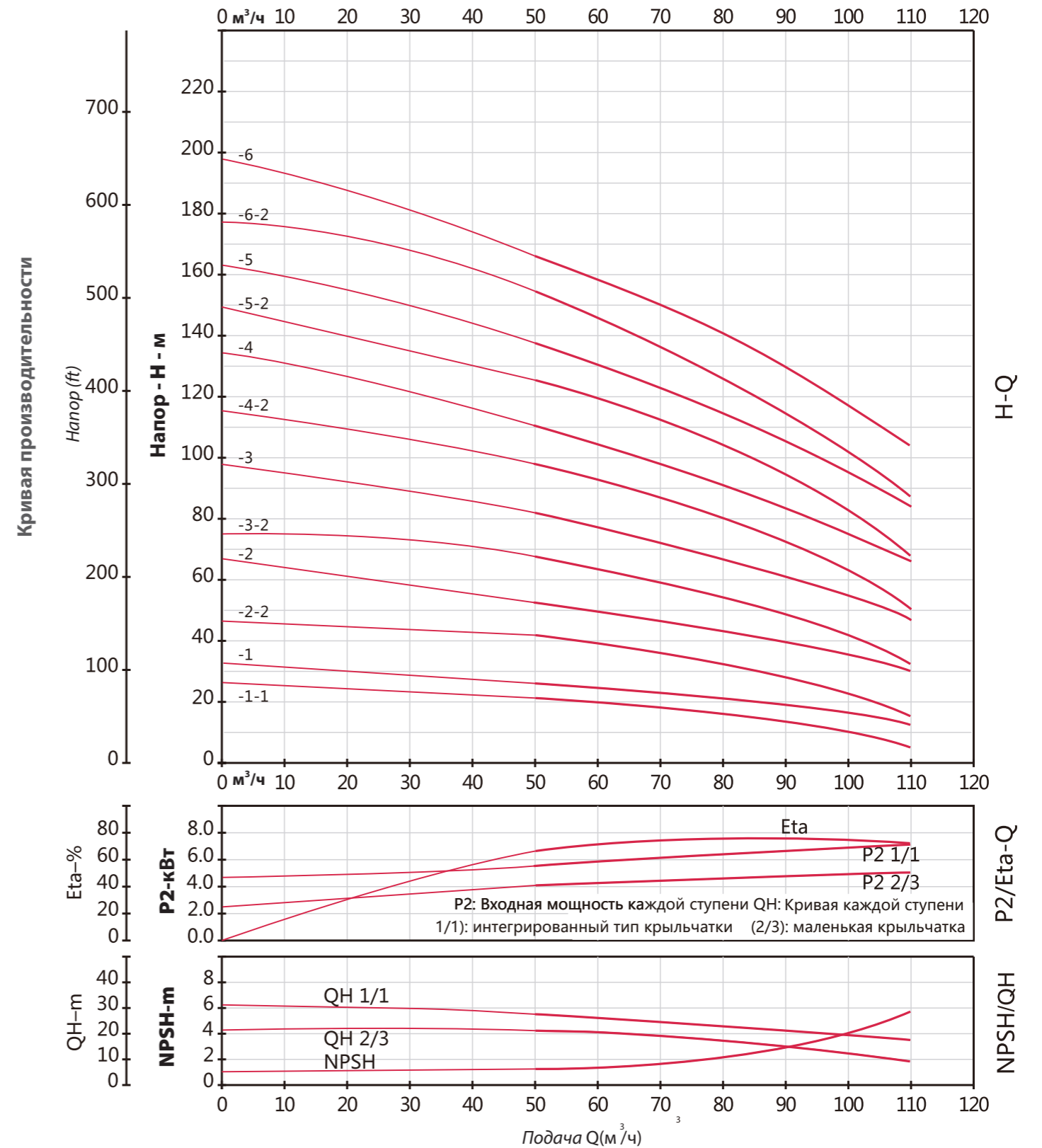

Размер и вес насоса

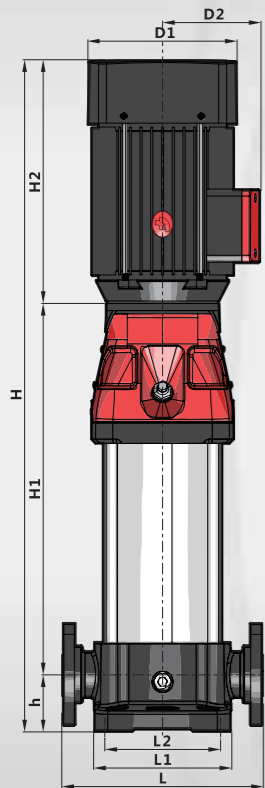

Модель	DN	Размер, мм					
		d1	d2	d3	d4	d5	d
CDM/F1	DN25	32	60	85	115	42	14
CDM/F3	DN25	32	60	85	115	42	14
CDM/F5	DN32	32	60	100	140	42	18
CDM/F10	DN40	50	80	110	150	60	18
CDM/F15	DN50	50	80	125	165	60	18
CDM/F20	DN50	50	80	125	165	60	18

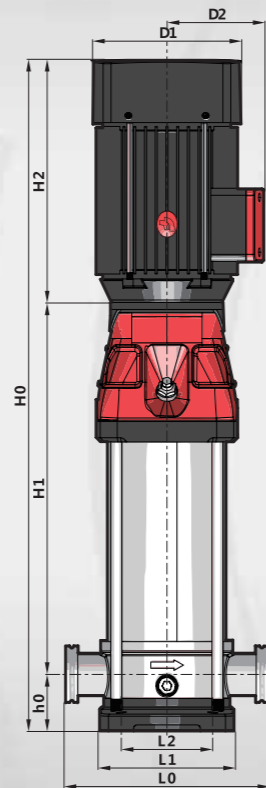
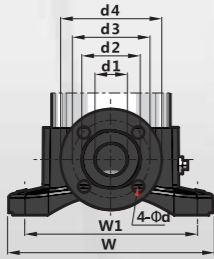

Модель	Размер, мм									
	L	L0	L1	L2	W	W1	D	h	h0	
CDM/F1	250	210	158	100	240	180	13	75	50	
CDM/F3	250	210	158	100	240	180	13	75	50	
CDM/F5	250	210	158	100	240	180	13	75	50	
CDM/F10	280	260	192	130	290	215	14	80	80	
CDM/F15	300	260	192	130	290	215	14	90	90	
CDM/F20	300	260	192	130	290	215	14	90	90	

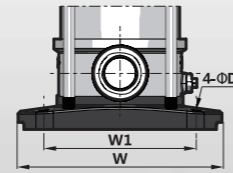

Модель	Размер, мм				Вес, кг		
	H1	H2	H/H0	D1	D2	CDM	CDMF
1-2	187	215	477/452	148	117	23	19
1-3	207	215	497/472	148	117	23	19
1-4	227	215	517/492	148	117	24	20
1-5	247	215	537/512	148	117	24	20
1-6	267	215	557/532	148	117	25	21
1-7	287	215	577/552	148	117	25	21
1-8	307	215	597/572	148	117	27	23
1-9	327	215	617/592	148	117	27	23
1-10	347	215	637/612	148	117	28	24
1-11	367	215	657/632	148	117	28	24
1-12	397	245	717/692	170	142	31	27
1-13	417	245	737/712	170	142	31	27
1-15	457	245	777/752	170	142	32	28
1-17	497	245	817/792	170	142	35	31
1-19	537	245	857/832	170	142	36	32
1-21	577	245	897/872	170	142	36	32
1-22	597	245	917/892	170	142	37	33
1-23	617	290	937/912	190	155	43	39
1-25	667	290	1032/1007	190	155	44	40
1-27	707	290	1072/1047	190	155	45	41
1-30	767	290	1132/1107	190	155	46	42
1-32	807	290	1172/1147	190	155	49	45
1-33	827	290	1192/1167	190	155	49	45
1-34	847	290	1212/1187	190	155	50	46
1-36	887	290	1252/1227	190	155	51	47
1-38	927	290	1292/1267	190	155	51	47
1-40	967	290	1332/1307	190	155	52	48

Модель	Размер, мм									
	H1	H2	H/H0	D1	D2	CDM	CDMF			
3-2	187	215	477/452	148	117	24	20			
3-3	207	215	497/472	148	117	24	20			
3-4	227	215	517/492	148	117	25	21			
3-5	247	215	537/512	148	117	26	22			
3-6	267	215	557/532	148	117	27	23			
3-7	297	245	617/592	170	142	30	26			
3-8	317	245	637/612	170	142	30	26			
3-9	337	245	657/632	170	142	32	28			
3-10	357	245	677/652	170	142	33	29			
3-11	377	245	697/672	170	142	33	29			
3-12	397	245	717/692	170	142	34	30			
3-13	427	290	792/767	190	155	39	35			
3-14	447	290	812/787	190	155	40	36			
3-15	467	290	832/807	190	155	40	36			
3-16	487	290	852/827	190	155	41	37			
3-18	527	290	892/867	190	155	43	39			
3-19	547	290	912/887	190	155	44	40			
3-20	567	290	932/907	190	155	44	40			
3-21	587	290	952/927	190	155	45	41			
3-22	607	290	972/947	190	155	45	41			
3-23	627	290	992/967	190	155	46	42			
3-24	647	290	1012/987	190	155	46	42			
3-25	677	345	1097/1072	197	165	57	53			
3-27	717	345	1137/1112	197	165	58	54			
3-28	737	345	1157/1132	197	165	58	54			
3-29	757	345	1177/1152	197	165	58	54			
3-31	797	345	1217/1192	197	165	59	55			

Размеры и вес

Модель	Размер, мм				Вес, кг		
	H1	H2	H/H0	D1	D2	CDM	CDMF
5-2	201	215	491/466	148	117	24	19
5-3	228	215	518/493	148	117	26	21
5-4	255	215	545/520	148	117	27	22
5-5	292	245	612/587	170	142	30	25
5-6	319	245	639/614	170	142	32	27
5-7	346	245	666/641	170	142	32	27
5-8	373	245	693/668	170	142	33	28
5-9	410	290	775/750	190	155	38	33
5-10	437	290	802/777	190	155	39	34
5-11	464	290	829/804	190	155	39	34
5-12	491	290	856/831	190	155	42	37
5-13	518	290	883/858	190	155	42	37
5-14	545	290	910/885	190	155	43	38
5-15	572	290	937/912	190	155	43	38
5-16	599	290	964/939	190	155	44	39
5-17	636	345	1056/1030	197	165	55	50
5-18	663	345	1083/1058	197	165	55	50
5-20	717	345	1137/1112	197	165	56	51
5-21	744	345	1164/1139	197	165	57	52
5-22	771	355	1201/1176	230	188	64	59
5-23	798	355	1228/1203	230	188	65	60
5-24	825	355	1255/1230	230	188	65	60
5-25	852	355	1282/1257	230	188	66	61
5-27	906	355	1336/1311	230	188	67	62
5-28	933	355	1363/1338	230	188	67	62
5-29	1035	390	1500/1475	260	208	87	82
5-30	1062	390	1527/1502	260	208	88	83
5-33	1143	390	1608/1583	260	208	89	84

Модель	Размер, мм				Вес, кг		
	H1	H2	H/H0	D1	D2	CDM	CDMF
15-1	297	245	632	170	142	40	33
15-2	307	290	687	190	155	48	41
15-3	362	345	797	197	165	59	52
15-4	407	355	852	230	188	66	59
15-5	452	355	897	230	188	68	61
15-6	575	390	1055	260	208	90	83
15-7	620	390	1100	260	208	91	84
15-8	665	390	1145	260	208	98	91
15-9	710	390	1190	260	208	99	92
15-10	785	500	175	330	255	157	150
15-11	830	500	1420	330	255	159	152
15-12	875	500	1465	330	255	160	153
15-13	920	500	1510	330	255	162	155
15-14	965	500	1555	330	255	163	156
15-15	1010	500	1600	330	255	179	172
15-16	1055	500	1645	330	255	181	174
15-17	1100	500	1690	330	255	182	175
15-18	1145	500	1735	330	255	184	177

Модель	Размер, мм					Вес, кг	
	H1	H2	H/H0	D1	D2	CDM	CDMF
10-1	267	245	592	170	142	31	29
10-2	267	245	592	170	142	32	30
10-3	297	245	622	170	142	35	33
10-4	337	290	707	190	155	41	39
10-5	367	290	737	190	155	45	43
10-6	397	290	767	190	155	46	44
10-7	437	345	862	197	165	57	55
10-8	467	345	892	197	165	58	56
10-9	497	355	932	230	188	65	63
10-10	527	355	962	230	188	66	64
10-11	557	355	992	230	188	67	65
10-12	665	355	1100	230	188	68	66
10-13	695	390	1165	260	208	88	86
10-14	725	390	1195	260	208	89	87
10-15	755	390	1225	260	208	90	88
10-16	785	390	1255	260	208	99	97
10-17	815	390	1285	260	208	100	98
10-18	845	390	1315	260	208	101	99
10-19	875	390	1345	260	208	102	100
10-20	905	390	1375	260	208	103	101
10-21	935	390	1405	260	208	104	102
10-22	995	500	1575	330	255	170	168

Модель	Размер, мм					Вес, кг	
	H1	H2	H/H0	D1	D2	CDM	CDMF
20-1	297	245	632	170	142	40	33
20-2	307	290	687	190	155	48	41
20-3	362	355	807	230	188	66	59
20-4	485	390	965	260	208	88	81
20-5	530	390	1010	260	208	90	83
20-6	575	390	1055	260	208	99	92
20-7	620	390	1100	260	208	100	93
20-8	695	500	1285	330	255		

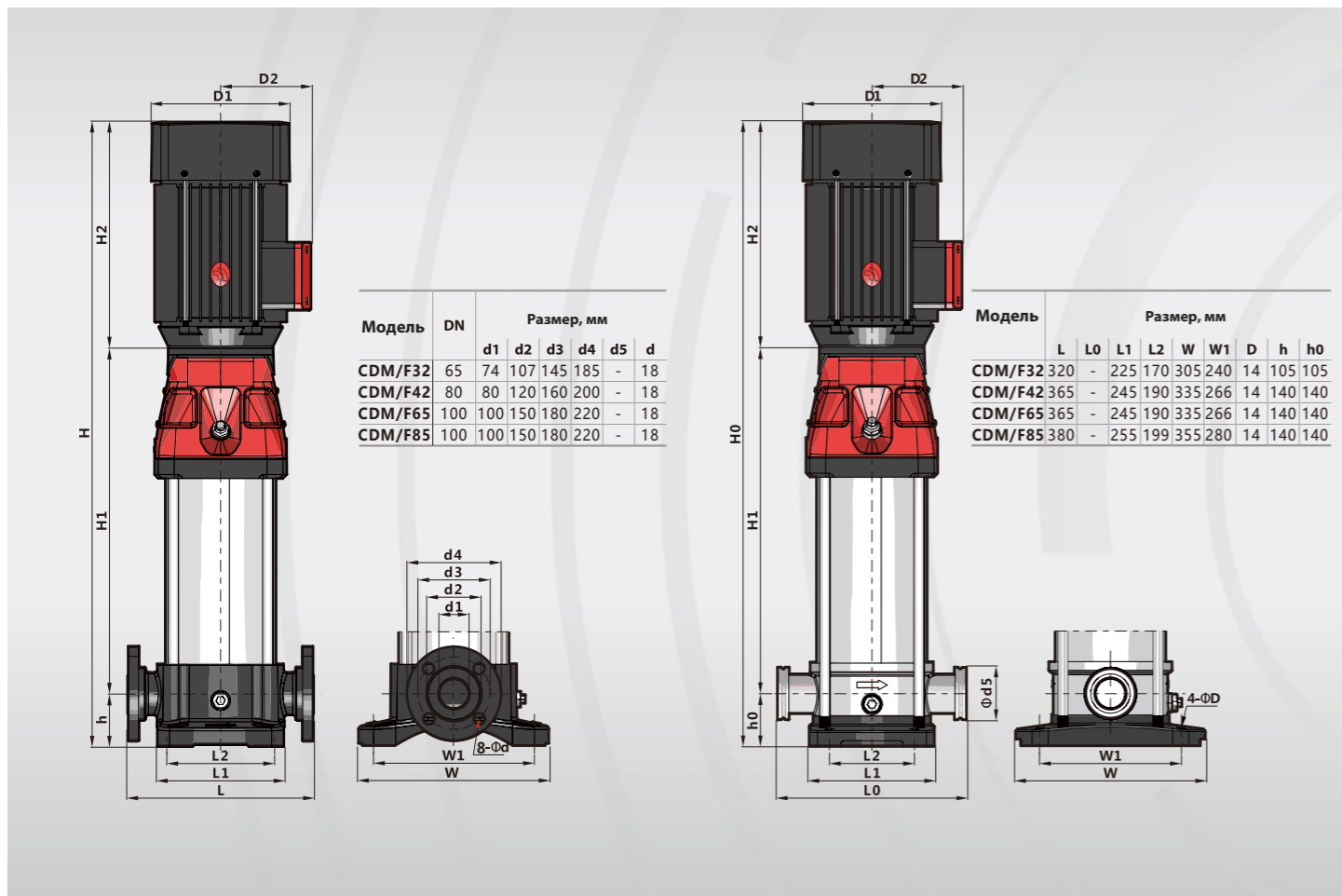

МОДЕЛЬ	H1 мм	H2 мм	H/H0 мм	D1 мм	D2 мм	CDM кг	CDMF кг
CDM32-1-1	329	290	724	190	155	66	54
CDM32-1	329	290	724	190	155	68	56
CDM32-2-2	399	345	849	197	165	73	69
CDM32-2	399	355	859	230	180	79	75
CDM32-3-2	560	390	1055	260	208	102	98
CDM32-3	560	390	1055	260	208	102	98
CDM32-4-2	630	390	1125	260	208	113	109
CDM32-4	630	390	1125	260	208	113	109
CDM32-5-2	730	500	1335	330	255	184	179
CDM32-5	730	500	1335	330	255	184	179
CDM32-6-2	800	500	1405	330	255	186	182
CDM32-6	800	500	1405	330	255	186	182
CDM32-7-2	870	500	1475	330	255	204	200
CDM32-7	870	500	1475	330	255	204	200
CDM32-8-2	940	500	1545	330	255	207	203
CDM32-8	940	500	1545	330	255	207	203

МОДЕЛЬ	H1 мм	H2 мм	H/H0 мм	D1 мм	D2 мм	CDM кг	CDMF кг
CDM32-9-2	1010	550	1665	330	255	218	214
CDM32-9	1010	550	1665	330	255	218	214
CDM32-10-2	1080	550	1735	330	255	221	217
CDM32-10	1080	550	1735	330	255	221	217
CDM32-11-2	1150	575	1830	360	285	277	272
CDM32-11	1150	575	1830	360	285	277	272
CDM32-12-2	1220	575	1900	360	285	280	275
CDM32-12	1220	575	1900	360	285	280	275
CDM32-13-2	1290	650	2045	400	310	343	339
CDM32-13	1290	650	2045	400	310	343	339
CDM32-14-2	1360	650	2115	400	310	346	342
CDM32-14	1360	650	2115	400	310	346	342
CDM32-15-2	1430	650	2185	400	310	349	345
CDM32-15	1430	650	2185	400	310	349	345
CDM32-16-2	1500	650	2255	400	310	352	347
CDM32-16	1500	650	2255	400	310	352	347

МОДЕЛЬ	H1 мм	H2 мм	H/H0 мм	D1 мм	D2 мм	CDM кг	CDMF кг
CDM42-1-1	350	345	835	197	165	83	73
CDM42-1	350	355	845	230	188	90	80
CDM42-2-2	521	390	1051	260	208	113	103
CDM42-2	521	390	1051	260	208	121	111
CDM42-3-2	631	500	1271	330	255	192	182
CDM42-3	631	500	1271	330	255	192	182
CDM42-4-2	711	500	1351	330	255	211	201
CDM42-4	711	500	1351	330	255	211	201
CDM42-5-2	791	550	1481	330	255	223	212
CDM42-5	791	550	1481	330	255	223	212
CDM42-6-2	871	575	1586	360	285	279	269
CDM42-6	871	575	1586	360	285	279	269
CDM42-7-2	951	650	1741	400	310	343	333
CDM42-7	951	650	1741	400	310	343	333
CDM42-8-2	1031	650	1821	400	310	347	337
CDM42-8	1031	650	1821	400	310	347	337
CDM42-9-2	1111	650	1901	400	310	350	340
CDM42-9	1111	650	1901	400	310	370	360
CDM42-10-2	1191	650	1981	400	310	374	364
CDM42-10	1191	650	1981	400	310	374	364
CDM42-11-2	1271	685	2096	450	345	477	467
CDM42-11	1271	685	2096	450	345	477	467
CDM42-12-2	1351	685	2176	450	345	481	471
CDM42-12	1351	685	2176	450	345	481	471
CDM42-13-2	1431	685	2256	450	345	484	474

МОДЕЛЬ	H1 мм	H2 мм	H/H0 мм	D1 мм	D2 мм	CDM кг	CDMF кг
CDM65-1-1	353	355	848	230	188	101	70
CDM65-1	444	390	974	260	208	121	90
CDM65-2-2	527	390	1057	260	208	133	102
CDM65-2-1	557	500	1197	330	255	201	170
CDM65-2	557	500	1197	330	255	201	170
CDM65-3-2	640	500	1280	330	255	219	188
CDM65-3-1	640	500	1280	330	255	219	188
CDM65-3	640	550	1330	330	255	227	196
CDM65-4-2	723	550	1413	330	255	231	200
CDM65-4-1	723	575	1438	360	285	284	253
CDM65-4	723	575	1438	360	285	284	253
CDM65-5-2	806	650	1596	400	310	349	318
CDM65-5-1	806	650	1596	400	310	349	318
CDM65-5	806	650	1596	400	310	349	318
CDM65-6-2	889	650	1679	400	310	353	322
CDM65-6-1	889	650	1679	400	310	373	342
CDM65-6	889	650	1679	400	310	373	342
CDM65-7-2	972	650	1762	400	310	377	346
CDM65-7-1	972	650	1762	400	310	377	346
CDM65-7	972	685	1797	460	340	477	446
CDM65-8-2	1055	685	1880	460	340	481	450
CDM65-8-1	1055	685	1880	460	340	481	450
CDM85-1-1	453	390	983	260	208	110	101
CDM85-1	453	390	983	260	208	118	109
CDM85-2-2	575	500	1215	330	255	190	181
CDM85-2	575	500	1215	330	255	205	196
CDM85-3-2	667	550	1357	330	255	217	208
CDM85-3	667	575	1382	360	285	270	261
CDM85-4-2	759	650	1549	400	310	335	326
CDM85-4	759	650	1549	400	310	335	326
CDM85-5-2	851	650	1641	400	310	359	350
CDM85-5	851	650	1641	400	310	359	350
CDM85-6-2	943	685	1768	460	340	463	454
CDM85-6	943	685	1768	460	340	463	454